





VALVOLE A MEMBRANA

- Realizzate seguendo rigorosamente i criteri e i test imposti dalle norme 3-A.
- Corpo in acciaio inossidabile AISI 316L realizzato mediante stampaggio a caldo, solubilizzato, lavorato meccanicamente e lucidato.
- Comandi manuali e pneumatici in acciaio inossidabile AISI 316L per sterilizzazioni a elevate temperature.
- Membrane in EPDM o PTFE. Membrane in EPDM e supporti elastici per le membrane in PTFE telati per conferire maggiore resistenza meccanica.
- Perfetta tenuta e completo isolamento da fattori inquinanti esterni.
- Completo autodrenaggio di tutte le parti interne durante le fasi di lavaggio CIP.
- Manutenzioni ridotte "top entry" con facilità di accesso e senza necessità di smontare la valvola dall'impianto.
- Produzione standard: estremità Clamp o estremità a saldare. A richiesta, disponibili con estremità filettate norme DIN, SMS, RJT, ISS o estremità flangiate UNI, DIN, ANSI.
- Finitura standard: lucidatura esterna e satinatura interna grana 150 (finitura LS); a richiesta, lucidatura esterna e interna grana 240 (finitura LL), lucidatura elettrolitica grana 400 (finitura LE).
- Max. pressione di esercizio: 7 bar.

DIAPHRAGM VALVES

- Produced in strict conformity with criteria and tests required by 3-A standards.
- Press-forged, solution heat-treated, machined and polished AISI 316L stainless steel body.
- AISI 316L stainless steel manual and pneumatic controls for high temperature sterilization.
- EPDM or PTFE diaphragms. EPDM diaphragms and elastic supports for the PTFE diaphragms fabric-finished to give high mechanical strength.
- Perfect seal and complete insulation from external pollutants.
- Complete self-drainage of all internal parts during CIP process.
- Reduced top-entry maintenance with easy access and no need to remove the valve from the system.
- Standard production: Clamp or welded ends. Available on request with threaded ends to DIN, SMS, RJT and ISS standards or flanged ends to UNI, DIN, ANSI standards.
- Standard finish: 150 grain external polishing and internal glazing (LS finish); on request 240 grain external and internal polishing (LL finish), 400 grain electrolytic polishing (LE finish).
- Maximum operating pressure: 7 bars.

VANNES À MEMBRANE

- Réalisées en respectant scrupuleusement les critères et les tests imposés par les normes 3-A.
- Corps en acier inoxydable AISI 316L réalisé par moulage à chaud, solubilisé, usiné mécaniquement et poli.
- Commandes manuelles et pneumatiques en acier inoxydable AISI 316L pour les stérilisations aux hautes températures.
- Membranes en EPDM ou PTFE. Membranes en EPDM et supports élastiques pour les membranes en PTFE toilées pour conférer une meilleure résistance mécanique.
- Étanchéité parfaite et isolation complète contre les facteurs polluants extérieurs.
- Autodrainage complet de toutes les parties internes durant les opérations de lavage CIP.
- Opérations d'entretien réduites "top entry", facilité d'accès et aucune nécessité de démonter la vanne de l'installation.
- Production standard: bouts Clamp ou bouts à souder. Sur demande, disponibles avec bouts filetés conformes aux normes DIN, SMS, RJT, ISS ou bouts bridés UNI, DIN, ANSI.
- Finissage standard: polissage extérieur et satinage intérieur grain 150 (finissage LS); sur demande, polissage extérieur et intérieur grain 240 (finissage LL), polissage électrolytique grain 400 (finissage LE).
- Pression d'exploitation maximum: 7 bars.



VÁLVULAS DE MEMBRANA

- Realizadas respectando rigurosamente los criterios y los test establecidos por las normas 3-A.
- Cuerpo de acero inoxidable AISI 316L realizado mediante estampado en caliente, solubilizado, trabajado mecánicamente y pulido.
- Mandos manuales y neumáticos de acero inoxidable AISI 316L para esterilizaciones a elevadas temperaturas.
- Membranas de EPDM o PTFE. Membranas de EPDM y soportes elásticos para las membranas de PTFE entretelados para otorgar mayor resistencia mecánica.
- Cierre perfecto y aislamiento completo de factores contaminantes exteriores.
- Autodrenaje completo de todas las piezas interiores durante el proceso de lavado CIP.
- Mantenimientos reducidos "top entry" con facilidad de acceso y sin necesidad de desmontar la válvula del sistema.
- Producción estándar: extremos Clamp o extremos para soldar. A pedido, disponibles con extremos fileteados según normas DIN, SMS, RJT, ISS o extremos rebordeados UNI, DIN, ANSI.
- Acabado estándar: pulido exterior y satinado interior grano 150 (acabado LS); a pedido, pulido exterior e interior grano 240 (acabado LL), pulido electrolítico grano 400 (acabado LE).
- Máxima presión de ejercicio: 7 bares.

MEMBRANE
DIAPHRAGMS
MEMBRANES
MEMBRANAS

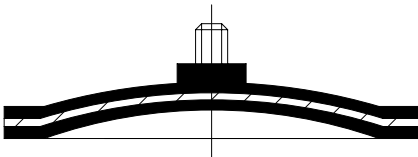

■ EPDM
-40°C + 150°C
-40°F + 300°F

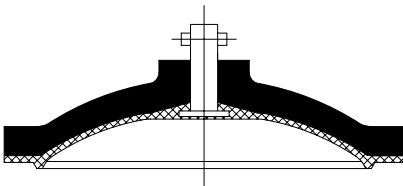

■ PTFE
-10°C + 150°C
+15°F + 300°F

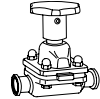

VALVOLA A MEMBRANA VANNE À MEMBRANE
DIAPHRAGM VALVE VÁLVULA DE MEMBRANA

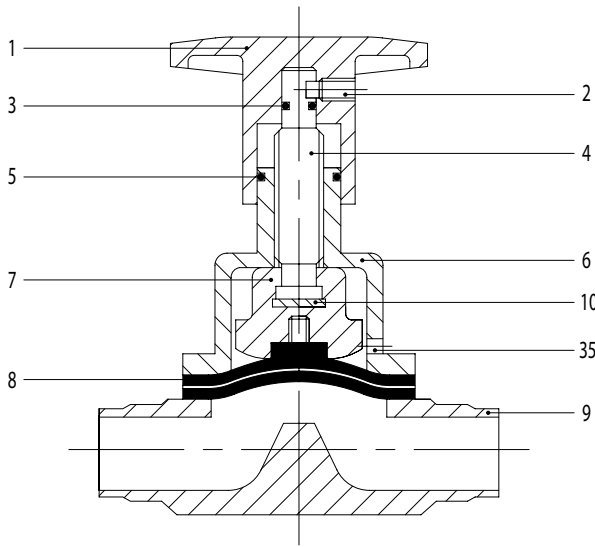

- | | |
|---|--|
| 1. Volantino
Handwheel
Volant
Manivela | 6. Comando
Control
Commande
Mando |
| 2. Grano
Dowel
Cheville
Pasador | 7. Compressore
Compressor
Compresseur
Compressor |
| 3. Anello di tenuta OR
OR seal ring
Joint torique
Junta OR | 8. Membrana
Diaphragm
Membrane
Membrana |
| 4. Stelo
Spindle
Came
Varilla | 9. Corpo valvola
Valve casing
Corps vanne
Cuerpo |
| 5. Anello di tenuta OR
OR seal ring
Joint torique
Junta OR | 10. Reggispinta
Thrust bearing
Butée
Cojinete de empuje |
| | 35. Foro rilevaz. perdite
Leakage detection hole
Trous relèvement pertes
Orificio desc. pérdida |

CODIFICAIONE
CODING
CODIFICATION
CODIFICACIÓN

Pos.	Cod. base	Norme	1/2"	3/4"	1"	1 1/2"	2"	Mat.	Part. o agg.
1	57		12/19	12/19	25	38	51	6L	01
2	GRA		M6	M6	M6	M8	M8	4L	
3	OR		2018	2018	106	114	114	N	
4	57		12/19	12/19	25	38	51	6L	04
5	OR		3056	3056	3068	3100	3100	N	
6	57		12	19	25	38	51	6L	06
7	57	E	12	19	25	38	51	6L	07
7	57	T	12	19	25	38	51	6L	07
8	57		12	19	25	38	51	E/T	08
9	57	W	12,7	19,05	25,4	38,1	50,8	6L	09
9	57	W	21,3	26,9	33,7	48,3	60,3	6L	09
9	57	L	12	18/22	28	40	52	6L	09
9	57	D	10	15/20	25	40	50	6L	09
9	57	K	12	19	25	38	51	6L	09
10	57	E	12/19	12/19	25	38/51	38/51	OT	10
10	57	T	12/19	12/19	25	38/51	38/51	OT	10



VALVOLA A MEMBRANA PNEUMATICA

NORMALMENTE APERTA

NORMALLY OPEN PNEUMATIC DIAPHRAGM VALVE

VANNE À MEMBRANE PNEUMATIQUE

NORMALEMENT OUVERTE

VÁLVULA NEUMÁTICA DE MEMBRANA

NORMALMENTE ABIERTA

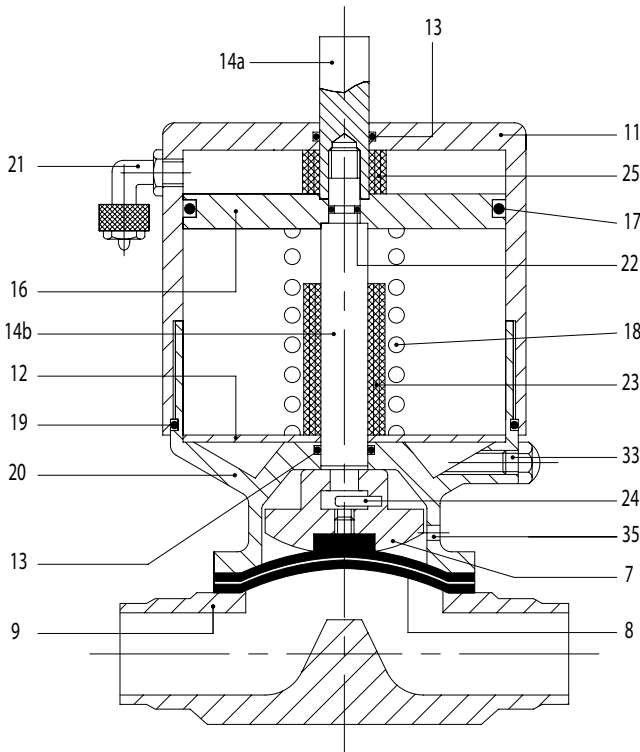

- | | |
|---|--|
| 7. Compressore
Compressor
Compresseur
Compresor | 18. Molla
Spring
Ressort
Muelle |
| 8. Membrana
Diaphragm
Membrane
Membrana | 19. Anello di tenuta OR
OR seal ring
Joint torique
Junta OR |
| 9. Corpo valvola
Valve body
Corps vanne
Cuerpo | 20. Cilindro
Cylinder
Cylindre
Cilindro |
| 11. Cappellotto cilindro
Cylinder cap
Capot cylindre
Capuchón cilindro | 21. Raccordo aria
Air union
Raccord air
Conexión para aire |
| 12. Disco
Disc
Disque
Disco | 22. Anello di tenuta OR
OR seal ring
Joint torique
Junta OR |
| 13. Anello di tenuta OR
OR seal ring
Joint torique
Junta OR | 23. Distanziale
Spacer
Entretoise
Distanciador |
| 14a. Stelo superiore
Upper stem
Tige supérieure
Varilla superior | 24. Spina
Plug
Broche
Enchufe |
| 14b. Stelo inferiore
Lower stem
Tige inférieure
Varilla inferior | 25. Distanziale superiore
Upper spacer
Entretoise supérieure
Distanciador superior |
| 16. Pistone
Piston
Piston
Pistón | 33. Uscita aria
Air vent
Décharge air
Descarga de aire |
| 17. Anello di tenuta OR
OR seal ring
Joint torique
Junta OR | 35. Foro rilevaz. perdite
Leakage detection hole
Trous relèvement pertes
Orificio desc. pérdida |

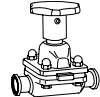

VALVOLA A MEMBRANA PNEUMATICA

NORMALMENTE CHIUSA

NORMALLY CLOSED PNEUMATIC DIAPHRAGM VALVE

VANNE À MEMBRANE PNEUMATIQUE

NORMALEMENT FERMÉE

VÁLVULA NEUMÁTICA DE MEMBRANA

NORMALMENTE CERRADA

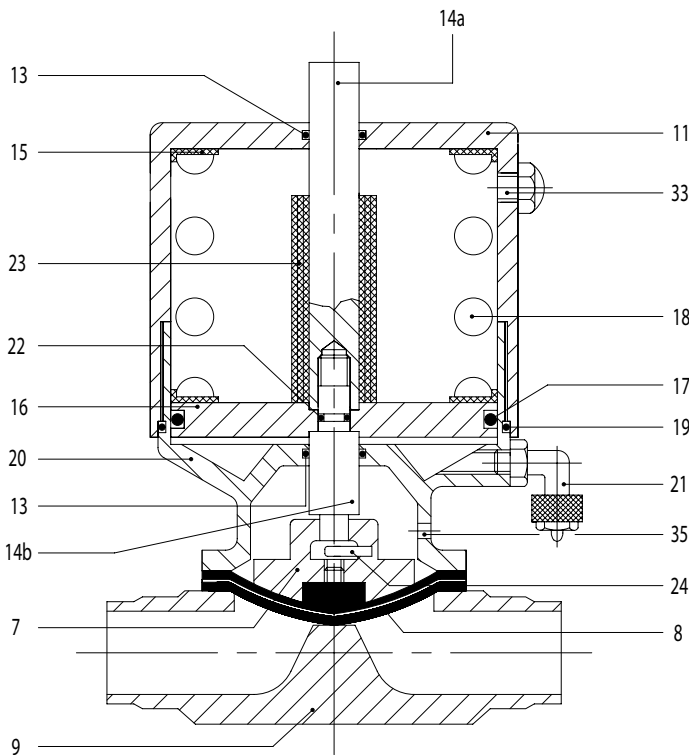

- | | |
|--|--|
| 7. Compressore
Compressor
Compresseur
Compresor | 17. Anello di tenuta OR
OR seal ring
Joint torique
Junta OR |
| 8. Membrana
Diaphragm
Membrane
Membrana | 18. Molla
Spring
Ressort
Muelle |
| 9. Corpo valvola
Valve body
Corps vanne
Cuerpo | 19. Anello di tenuta OR
OR seal ring
Joint torique
Junta OR |
| 11. Cappello cilindro
Cylinder cap
Capot cylindre
Capuchón cilindro | 20. Cilindro
Cylinder
Cylindre
Cilindro |
| 13. Anello di tenuta OR
OR seal ring
Joint torique
Junta OR | 21. Raccordo aria
Air union
Raccord air
Racor del aire |
| 14a. Stelo superiore
Upper stem
Tige supérieure
Varilla superior | 22. Anello di tenuta OR
OR seal ring
Joint torique
Junta OR |
| 14b. Stelo inferiore
Lower stem
Tige inférieure
Varilla inferior | 23. Distanziale
Spacer
Entretoise
Distanciador |
| 15. Guida molla
Spring holder
Guide ressort
Guía muelle | 24. Spina
Plug
Broche
Enchufe |
| 16. Pistone
Piston
Piston
Pistón | 33. Uscita aria
Air vent
Décharge air
Descarga de aire |
| | 35. Foro rilevaz. perdite
Leakage detection hole
Trous relèvement pertes
Orificio desc. pérdida |



VALVOLA A MEMBRANA PNEUMATICA

NORMALMENTE APERTA CON UNITÀ DI CONTROLLO

NORMALLY OPEN PNEUMATIC DIAPHRAGM

VALVE WITH CONTROL UNIT

VANNE À MEMBRANE PNEUMATIQUE

NORMALEMENT OUVERTE AVEC UNITÉ DE CONTRÔLE

VÁLVULA NEUMÁTICA DE MEMBRANA

NORMALMENTE ABIERTA CON UNIDAD DE CONTROL

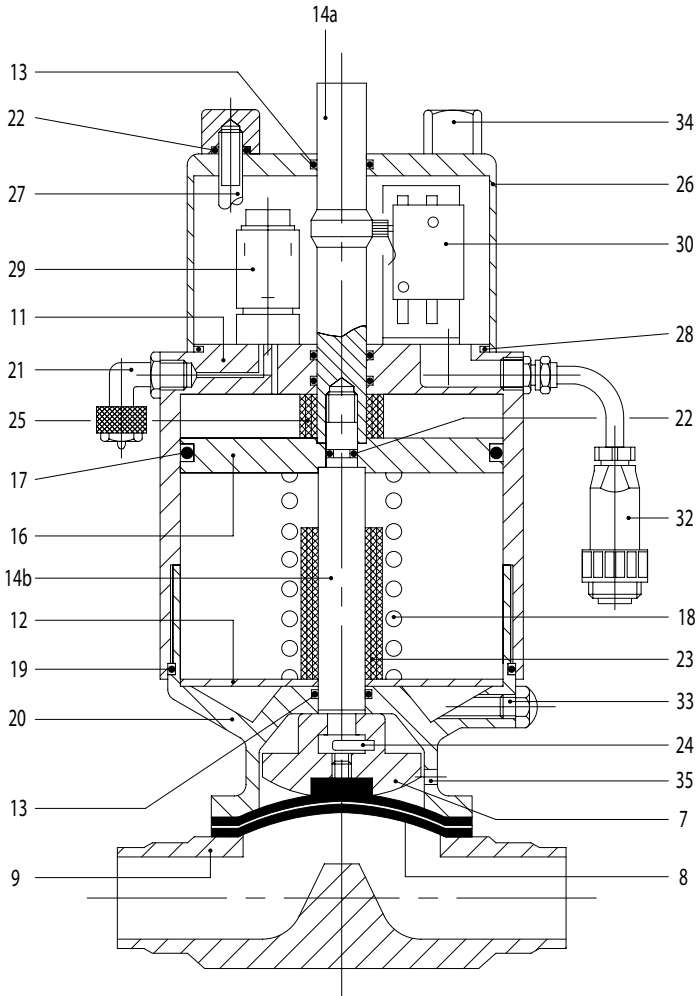

- | | |
|--|--|
| 7. Compressore
Compressor
Compresseur
Compresor | 21. Raccordo aria
Air union
Raccord air
Racor del aire |
| 8. Membrana
Diaphragm
Membrane
Membrana | 22. Anello di tenuta OR
OR seal ring
Joint torique
Junta OR |
| 9. Corpo valvola
Valve body
Corps vanne
Cuerpo | 23. Distanziale
Spacer
Entretoise
Distanciador |
| 11. Cappello cilindro
Cylinder cap
Capot cylindre
Capuchón cilindro | 24. Spina
Plug
Broche
Enchufe |
| 12. Disco
Disc
Disque
Disco | 25. Distanziale superiore
Upper spacer
Entretoise supérieure
Distanciador |
| 13. Anello di tenuta OR
OR seal ring
Joint torique
Junta OR | 26. Cappello unità contr.
Control unit cap
Capot unité contrôle
Capuc. unidad control |
| 14a. Stelo superiore
Upper stem
Tige supérieure
Varilla superior | 27. Tirante
Tie rod
Tirant
Tirante |
| 14b. Stelo inferiore
Lower stem
Tige inférieure
Varilla inferior | 28. Anello di tenuta OR
OR seal ring
Joint torique
Junta OR |
| 16. Pistone
Piston
Piston
Pistón | 29. Elettrovalvola
Solenoid valve
Électrovanne
Electroválvula |
| 17. Anello di tenuta OR
OR seal ring
Joint torique
Junta OR | 30. Microinterruttore
Microswitch
Minirupteur
Microrruptor |
| 18. Molla
Spring
Ressort
Muelle | 32. Connettore
Connector
Connecteur
Conector |
| 19. Anello di tenuta OR
OR seal ring
Joint torique
Junta OR | 33. Uscita aria
Air vent
Décharge air
Descarga de aire |
| 20. Cilindro
Cylinder
Cylindre
Cilindro | 34. Dado
Nut
Écrou
Tuerca |
| | 35. Foro rilevaz. perdite
Leakage detection hole
Trous relèvement pertes
Orificio desc. pérdida |

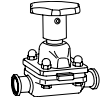

VALVOLA A MEMBRANA PNEUMATICA

NORMALMENTE CHIUSA CON UNITÀ DI CONTROLLO

NORMALLY CLOSED PNEUMATIC DIAPHRAGM

VALVE WITH CONTROL UNIT

VANNE À MEMBRANE PNEUMATIQUE

NORMALEMENT FERMÉE AVEC UNITÉ DE CONTRÔLE

VÁLVULA NEUMÁTICA DE MEMBRANA

NORMALMENTE CERRADA CON UNIDAD DE CONTROL

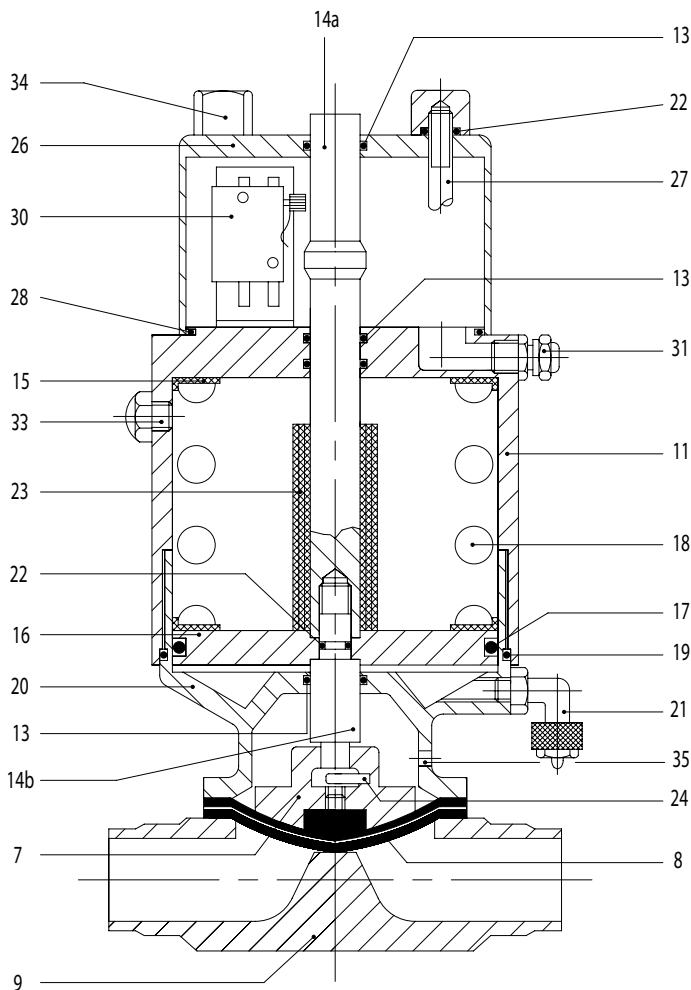

- | | |
|--|--|
| 7. Compressore
Compressor
Compresseur
Compresor | 20. Cilindro
Cylinder
Cylindre
Cilindro |
| 8. Membrana
Diaphragm
Membrane
Membrana | 21. Raccordo aria
Air union
Raccord air
Racor del aire |
| 9. Corpo valvola
Valve body
Corps vanne
Cuerpo | 22. Anello di tenuta OR
OR seal ring
Joint torique
Junta OR |
| 11. Cappello cilindro
Cylinder cap
Capot cylindre
Capuchón cilindro | 23. Distanziale
Spacer
Entretoise
Distanciador |
| 13. Anello di tenuta OR
OR seal ring
Joint torique
Junta OR | 24. Spina
Plug
Broche
Enchufe |
| 14a. Stelo superiore
Upper stem
Tige supérieure
Varilla superior | 26. Cappello unità contr.
Control unit cap
Capot unité contrôle
Capuc. unidad control |
| 14b. Stelo inferiore
Lower stem
Tige inférieure
Varilla inferior | 27. Tirante
Tie rod
Tirant
Tirante |
| 15. Guida molla
Spring holder
Guide ressort
Guía muelle | 28. Anello di tenuta OR
OR seal ring
Joint torique
Junta OR |
| 16. Pistone
Piston
Piston
Pistón | 30. Microinterruttore
Microswitch
Minirrupteur
Microruptor |
| 17. Anello di tenuta OR
OR seal ring
Joint torique
Junta OR | 31. Pressacavo
Cable-grommet
Presse-câble
Sujeta cables |
| 18. Molla
Spring
Ressort
Muelle | 33. Uscita aria
Air vent
Décharge air
Descarga de aire |
| 19. Anello di tenuta OR
OR seal ring
Joint torique
Junta OR | 34. Dado
Nut
Écrou
Tuerca |
| | 35. Foro rilevaz. perdita
Leakage detection hole
Trous relèvement pertes
Orificio desc. pérdida |



CODIFICAZIONE
CODING
CODIFICATION
CODIFICACIÓN

Pos.	Cod. base	Norme	1/2"	3/4"	1"	1 1/2"	2"	Mat.	Part. o agg.
7	57	E	12	19	25	38	51	6L	07
7	57	T	12	19	25	38	51	6L	07
8	57		12	19	25	38	51	E	08
8	57		12	19	25	38	51	T	08
9	57	W	12,7	19,05	25,4	38,1	50,8	6L	09
9	57	K	12	19	25	38	51	6L	09
11	58		12	19/25	19/25	38/51	38/51	4L	11
12	58	NA	12	19/25	19/25	38/51	38/51	4L	12
13	OR		3056	123	123	123	123	N	
14a	58	NA	12	19	25	38	51	6L	14a
14b	58	NA	12	19/25	19/25	38/51	38/51	6L	14b
14a	58	NC	12	19	25	38	51	6L	14a
14b	58	NC	12	19/25	19/25	38/51	38/51	6L	14b
15	58		12	12	12	12	12	T	15
16	58		12	19/25	19/25	38/51	38/51	AL	16
17	OR		6150	6275	6275	6400	6400	N	
18	58		NA 12	12	12	NA 38/51	NA 38/51	4L	18
19	OR		3206	3325	3325	3450	3450	N	
20	58		12	19	25	38	51	6L	20
21	58		1/8"	1/8"	1/8"	1/8"	1/8"	4L	
22	OR		106	108	108	108	108	N	
23	58	NA	12	19	25	38	51	T	23
23	58	NC	12	19	25	38	51	T	23
24	58		3x15	3x15	3x15	3x15	3x15	6L	24
25	58	NA	12	19	25	38	51	T	25
26	60		12	19/25	19/25	38/51	38/51	4L	26
27	60		12/51	12/51	12/51	12/51	12/51	4L	27
28	OR		2262	2300	2300	2375	2375	N	
29	015		U	U	U	U	U		
30	014		1	1	1	1	1		
31	026		12/51	12/51	12/51	12/51	12/51	4L	31
32	030 S		S	S	S	S	S		
33	58		1/8"	1/8"	1/8"	1/8"	1/8"	4L	33
34	60		12/51	12/51	12/51	12/51	12/51	4L	34



CONNESSIONI
ENDS
BOUTS
EXTREMOS

DN	BS			SCHEDULE				ISO		DIN					
	D.E.	+16 swg	18 swg	D.E.	5S	10S	40S	D.E.	Sp.	Serie 1		Serie 2		Serie 3	
		Sp.	Sp.		Sp.	Sp.	Sp.			D.E.	Sp.	D.E.	Sp.	D.E.	Sp.
15	12,70	1,63	1,22	21,34	1,65	2,11	2,77	21,3	1,6	18	1	19	1,5	20	2
20	19,05	1,63	1,22	26,67	1,65	2,11	2,87	26,9	1,6	22	1	23	1,5	24	2
25	25,40	1,63	1,22	33,40	1,65	2,77	3,38	33,7	2,0	28	1	29	1,5	30	2
40	38,10	1,63	1,22	48,26	1,65	2,77	3,68	48,3	2,0	40	1	41	1,5	42	2
50	50,80	1,63	1,22	60,33	1,65	2,77	3,91	60,3	2,6	52	1	53	1,5	54	2

VALORI CV E KV
CV AND KV VALUES
VALEURS CV ET KV
VALORES CV Y KV

%	DN 15 1/2"		DN 20 3/4"		DN 25 1"		DN 40 1 1/2"		DN 50 2"	
APERTURA OPENING OUVERTURE APERTURA	CV (US gal/min)	KV (l/s)	CV (US gal/min)	KV (l/s)	CV (US gal/min)	KV (l/s)	CV (US gal/min)	KV (l/s)	CV (US gal/min)	KV (l/s)
100	6,7	1,6	13,3	3,16	20	4,76	50	12	101	24,04
90	6,4	1,5	12,8	3,04	19,2	4,57	48	11,4	97	23,1
80	6,11	1,45	12,3	2,9	18,4	4,37	46	11	92,9	22,1
70	5,85	1,4	11,7	2,8	17,6	4,2	44	10,5	88,9	21,15
60	5,58	1,32	11,2	2,65	16,8	4	42	10	84,83	20,2
50	4,65	1,1	9,3	2,2	14	3,33	35	8,4	70,7	16,83
40	3,7	0,9	7,45	1,76	11,2	2,66	28	6,7	56,5	13,46
30	2,8	0,65	5,6	1,3	8,4	2	21	5	42,4	10,1
20	1,85	0,43	3,7	0,9	5,6	1,33	14	3,8	28,27	6,73
10	0,92	0,21	1,85	0,43	2,8	0,66	7	1,66	14,13	3,36
0	0		0		0		0		0	

DIMENSIONI, VOLUMI E TEMPI DI MANOVRA
DIMENSIONS, AIR VOLUMES AND OPERATING TIMES
DIMENSIONES, VOLUMES ET TEMPS DE MANOEUVRE
DIMENSIONES, VOLUMENES Y TIEMPOS DE MANIOBRA

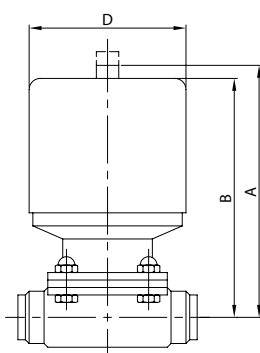

Diam. valvola Valve diam. Diam. vanne Diam. válvula	A	B	D	Vol. Aria chiude Air closes Air ferme Aire cierra	Vol. Aria apre Air opens Air ouvre Aire abre	Tempi Time Temps Tiempos
mm	mm	mm	mm	cm ³	cm ³	s
15	118	111	60	50	20	1
20	127	120	89	230	65	1
25	132	124	89	230	65	1
40	196	186	129	1000	250	2
50	210	200	129	1000	350	2

Diam. valvola Valve diam. Diam. vanne Diam. válvula	A	B	D	Vol. Aria chiude Air closes Air ferme Aire cierra	Vol. Aria apre Air opens Air ouvre Aire abre	Tempi Time Temps Tiempos
in	in	in	in	in ³	in ³	s
1/2"	4 5/8"	4 3/8"	2 3/8"	3	1	1
3/4"	5"	4 5/8"	3 1/2"	13	4	1
1"	5 1/4"	4 7/8"	3 1/2"	13	4	1
1 1/2"	7 5/8"	7 3/8"	5 1/8"	60,5	15	2
2"	8 1/4"	7 7/8"	5 1/8"	61	20	2

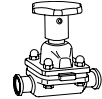

MICROVALVOLA M. EL.
D. MICROVALVE PE.
MINIVANNE MEMBR. EL.
MICROVALVULA M. EL.

S57W

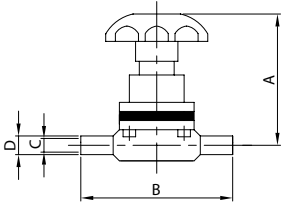

DN	A	B	C	D	gr
6	66,5	67,0	3,9	6,3	190
9	66,5	67,0	7,1	9,5	190
12	66,5	67,0	9,4	12,7	190

MICROVALVOLA M. E. SM.
D. MICROVALVE E. FR.
MINIVANNE MEMBR. B. FR.
MICROVALVULA M. E. SM.

S57K

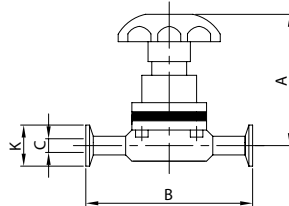

DN	A	B	C	K	gr
12	66,5	67,0	9,4	25,0	200

V. MEMBRANA EL.
DIAPHRAGM V. PE.
V. MEMBRANA BL.
V. MEMBRANA EL.

57W

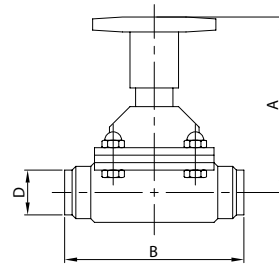

DN	A	B	D	gr
12	78,0	89,0	12,7	840
19	79,0	102,0	19,0	1.200
25	92,0	114,0	25,4	1.680
38	112,0	140,0	38,1	3.140
51	135,0	159,0	50,8	5.040

V. MEMBRANA E. SM.
DIAPHRAGM V. E. FR.
V. MEMBRANA B. FR.
V. MEMBRANA E. SM.

57K

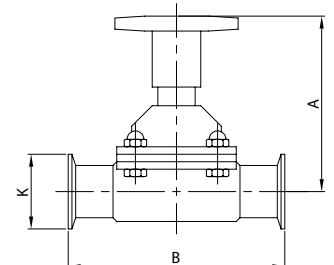

DN	A	B	K	gr
12	78,0	89,0	25,0	840
19	79,0	102,0	25,0	1.200
25	92,0	114,0	50,5	1.680
38	112,0	140,0	50,5	3.140
51	135,0	159,0	64,0	5.040

V. M. PNEUMATICA EL.
PNEUMATIC D. V. PE.
V. M. PNEUMATIQUE BL.
V. M. NEUMÁTICA EL.

58W

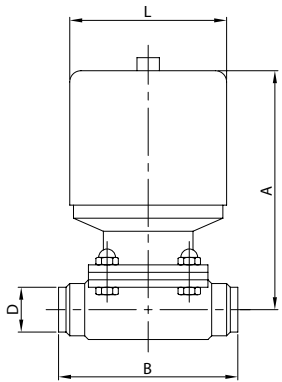

DN	A	B	D	L	gr
12	107,0	89,0	12,7	60,0	1.360
19	120,0	102,0	19,0	90,0	2.460
25	124,0	114,0	25,4	90,0	2.780
38	186,0	140,0	38,1	127,0	6.880
51	200,0	159,0	50,8	127,0	8.160

V. M. PNEUMATICA E. SM.
PNEUMATIC D. V. E. FR.
V. M. PNEUMATIQUE B. FR.
V. M. NEUMÁTICA E. SM.

58K

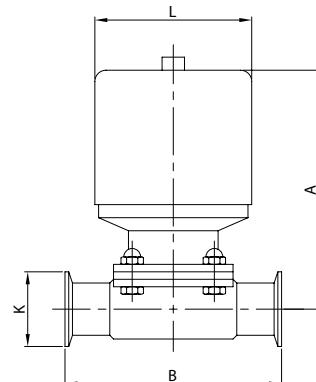

DN	A	B	K	L	gr
12	107,0	89,0	25,0	60,0	1.360
19	120,0	102,0	25,0	90,0	2.460
25	124,0	114,0	50,5	90,0	2.780
38	186,0	140,0	50,5	127,0	6.880
51	200,0	159,0	64,0	127,0	8.160

V. M. UN. CONTROLLO EL.
D. V. CONTROL UNIT PE.
V. M. UN. CONTRÔLE BL.
V. M. UN. CONTROL EL.

60W

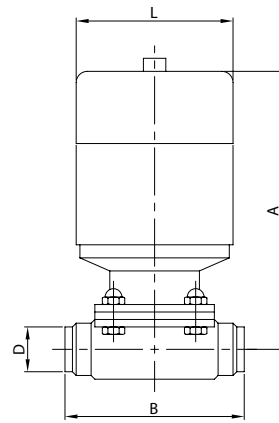

DN	A	B	D	L	gr
12	183,0	89,0	12,7	60,0	1.660
19	197,0	102,0	19,0	90,0	3.010
25	201,0	114,0	25,4	90,0	3.330
38	263,0	140,0	38,1	127,0	7.880
51	277,0	159,0	50,8	127,0	9.160

V. M. UN. CONTROLLO E. SM.
D. V. CONTROL UNIT E. FR.
V. M. UN. CONTRÔLE B. FR.
V. M. UN. CONTROL E. SM.

60K

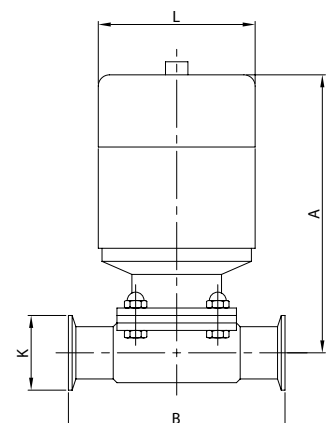

DN	A	B	K	L	gr
12	183,0	89,0	25,0	60,0	1.660
19	197,0	102,0	25,0	90,0	3.010
25	201,0	114,0	50,5	90,0	3.330
38	263,0	140,0	50,5	127,0	7.880
51	277,0	159,0	64,0	127,0	9.160



VALVOLE A MEMBRANA
DIAPHRAGM VALVES
VANNES À MEMBRANE
VÁLVULAS DE MEMBRANA

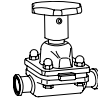

V. MEMBRANA 3 V. T EL.
DIAPHRAGM V. 3 W. T PE.
V. MEMBRANE 3 V. T BL.
V. MEMBRANA 3 V. T EL.

V. MEMBR. 3 V. T E. SM.
DIAPHR. V. 3 W. T FR.
V. MEMBR. 3 V. T B. FR.
V. MEMBR. 3 V. T E. SM.

V. M. PNEUM. 3 V. T EL.
PNEUM. D. V. 3 W. T PE.
V. M. PNEUM. 3 V. T BL.
V. M. NEUM. 3 V. T EL.

V. M. PN. 3 V. T E. SM.
PN. D. V. 3 W. T E. FR.
V. M. PN. 3 V. T B. FR.
V. M. NEUM. 3 V. T E. SM.

ZDT 57W

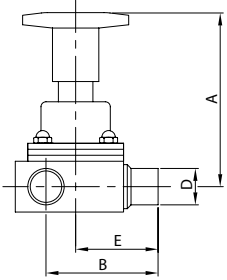

ZDT 57K

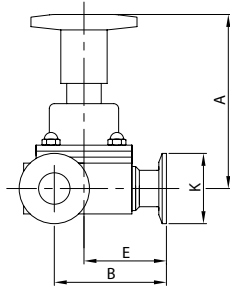

ZDT 58W

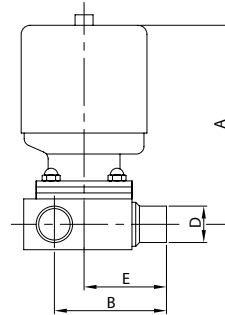

ZDT 58K

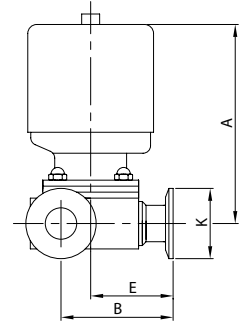

DN	A	B	D	E	gr
12	97,5	56,5	12,7	44,5	840
19	99,0	66,5	19,0	51,0	1.200
25	120,0	80,0	25,4	57,0	1.680
38	156,0	101,5	38,1	70,0	3.140
51	182,0	118,5	50,8	79,5	5.040

DN	A	B	E	K	gr
12	97,5	56,5	44,5	25,0	840
19	99,0	66,5	51,0	25,0	1.200
25	120,0	80,0	57,0	50,5	1.680
38	156,0	101,5	70,0	50,5	3.140
51	182,0	118,5	79,5	64,0	5.040

DN	A	B	D	E	gr
12	111,0	56,5	12,7	44,5	1.360
19	123,0	66,5	19,0	51,0	2.460
25	129,0	80,0	25,4	57,0	2.780
38	189,0	101,5	38,1	70,0	6.880
51	201,0	118,5	50,8	79,5	8.160

DN	A	B	E	K	gr
12	111,0	56,5	44,5	25,0	1.360
19	123,0	66,5	51,0	25,0	2.460
25	129,0	80,0	57,0	50,0	2.780
38	189,0	101,5	70,0	50,5	6.880
51	201,0	118,5	79,5	64,0	8.160

V. M. UN. C. 3 V. T EL.
D. V. C. UNIT 3 W. T PE.
V. M. UN. CONTR. 3 V. T BL.
V. M. UN. CONTR. 3 V. T EL.

V. M. UN. C. 3 V T E. SM.
D. V. C. UN. 3 W. T E. FR.
V. M. UN. C. 3 V. T B. FR.
V. M. UN. C. 3 V. T E. SM.

V. M. PRELIEVO EL.
SAMPLING D. V. PE.
V. M. PRISE ECHANT. EL.
V. M. TOMAMUESTRAS EL.

V. M. PRELIEVO E. SM.
SAMPLING D. V. E. FR.
V. M. PRISE ECHANT. B. FR.
V. M. TOMAM. E. SM.

ZDT 60W

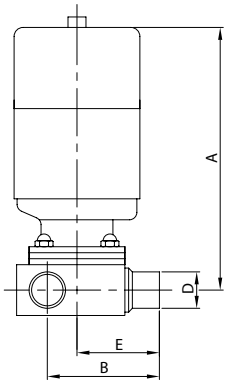

ZDT 60K

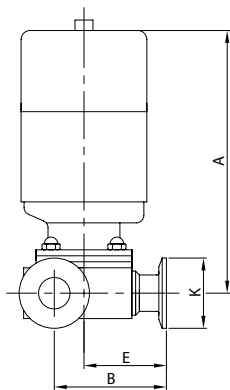

ZDL 57W

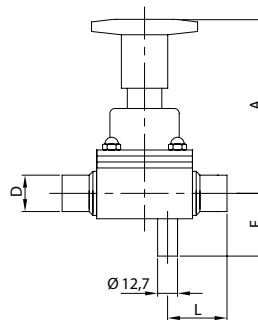

ZDL 57K

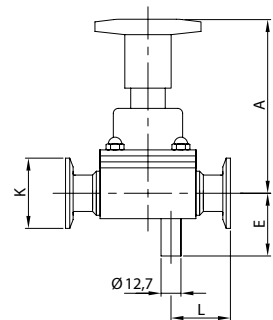

DN	A	B	D	E	gr
12	187,0	56,5	12,7	44,5	1.660
19	200,0	66,5	19,0	51,0	3.010
25	206,0	80,0	25,4	57,0	3.330
38	266,0	101,5	38,1	70,0	7.880
51	278,0	118,5	50,8	79,5	9.160

DN	A	B	E	K	gr
12	187,0	56,5	44,5	25,0	1.660
19	200,0	66,5	51,0	25,0	3.010
25	206,0	80,0	57,0	50,5	3.330
38	266,0	101,5	70,0	50,5	7.880
51	278,0	118,5	79,5	64,0	9.160

DN	A	D	E	L	gr
12	94,5	12,7	34,5	27,0	840
19	96,0	19,0	39,0	32,0	1.200
25	116,0	25,4	42,0	37,0	1.680
38	155,0	38,1	59,0	42,0	3.140
51	182,0	50,8	66,0	46,0	5.040

DN	A	E	K	L	gr
12	94,5	34,5	25,0	27,0	840
19	96,0	39,0	25,0	32,0	1.200
25	116,0	42,0	50,5	37,0	1.680
38	155,0	59,0	50,5	42,0	3.140
51	182,0	66,0	64,0	46,0	5.040

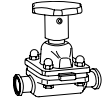

V. M. PNEUM. PRELIEVO EL.
SAMPLING PN. D. V. PE.
V. M. PN. PRISE ECH. EL.
V. M. NEUM. TOMAM. EL.

ZDL 58W

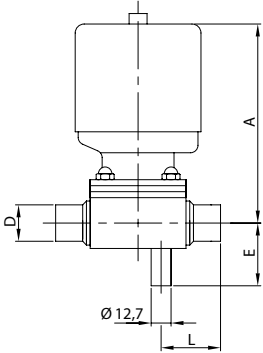

DN	A	D	E	L	gr
12	107,0	12,7	34,5	27,0	1.360
19	120,0	19,0	39,0	32,0	2.460
25	124,0	25,4	42,0	37,0	2.780
38	186,0	38,1	59,0	42,0	6.880
51	200,0	50,8	66,0	46,0	8.160

V. M. PNEUM. PREL. E. SM.
SAMPL. PN. D. V. E. FR.
V. M. PN. PRISE ECH. B. FR.
V. M. NEUM. TOMAM. E. SM.

ZDL 58K

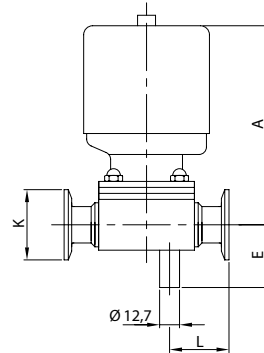

DN	A	E	K	L	gr
12	107,0	34,5	25,0	27,0	1.360
19	120,0	39,0	25,0	32,0	2.460
25	124,0	42,0	50,5	37,0	2.780
38	186,0	59,0	50,5	42,0	6.880
51	200,0	66,0	64,0	46,0	8.160

V. M. PNEUM. PREL. E. SM.
SAMPL. PN. D. V. E. FR.
V. M. PN. PRISE ECH. B. FR.
V. M. NEUM. TOMAM. E. SM.

ZDL 60W

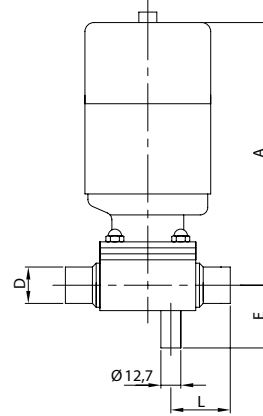

DN	A	D	E	L	gr
12	183,0	12,7	34,5	27,0	1.660
19	197,0	19,0	39,0	32,0	3.010
25	201,0	25,4	42,0	37,0	3.330
38	263,0	38,1	59,0	42,0	7.880
51	277,0	50,8	66,0	46,0	9.160

V. M. U. C. PREL. E. SM.
SAMPL. D. V. C. UN. E. FR.
V. M. U. C. PRISE ECH. B. FR.
V. M. U. C. TOMAM. E. SM.

ZDL 60K

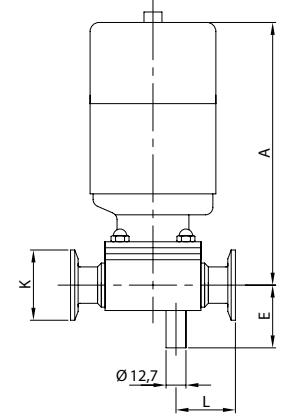

DN	A	E	K	L	gr
12	183,0	34,5	25,0	27,0	1.660
19	197,0	39,0	25,0	32,0	3.010
25	201,0	42,0	50,5	37,0	3.330
38	263,0	59,0	50,5	42,0	7.880
51	277,0	66,0	64,0	46,0	9.160

V. M. PRELIEVO 20° EL.
20° SAMPLING D. V. PE.
V. M. PRISE ECH. 20° EL.
V. M. TOMAM. 20° EL.

D2L 57W

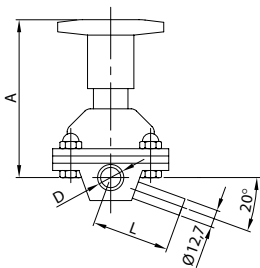

DN	A	D	L	gr
12	94,5	12,7	46,0	840
19	96,0	19,0	50,0	1.200
25	116,0	25,4	55,0	1.680
38	155,0	38,1	71,0	3.140
51	182,0	50,8	84,0	5.040

V. M. PRELIEVO 20° E. SM.
20° SAMPLING D. V. E. FR.
V. M. PRISE ECH. 20° B. FR.
V. M. TOMAM. 20° E. SM.

D2L 57K

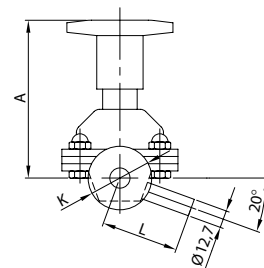

DN	A	K	L	gr
12	94,5	25,0	46,0	840
19	96,0	25,0	50,0	1.200
25	116,0	50,5	55,0	1.680
38	155,0	50,5	71,0	3.140
51	182,0	64,0	84,0	5.040

V. M. PNEUM. PREL. 20° EL.
20° SAMPL. PN. D. V. PE.
V. M. PN. PR. ECH. 20° BL.
V. M. NEUM. TOMAM. 20° EL.

D2L 58W

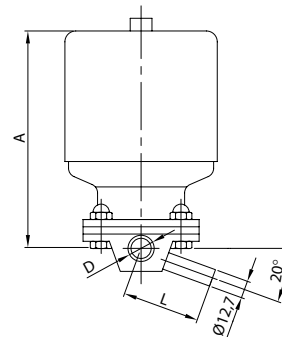

DN	A	D	L	gr
12	107,0	12,7	46,0	1.360
19	120,0	19,0	50,0	2.460
25	124,0	25,4	55,0	2.780
38	186,0	38,1	71,0	6.880
51	200,0	50,8	84,0	8.160

V. M. PN. PREL. 20° E. SM.
20° SAMPL. PN. D. V. E. FR.
V. M. PN. PR. ECH. 20° B. FR.
V. M. N. TOMAM. 20° E. SM.

D2L 58K

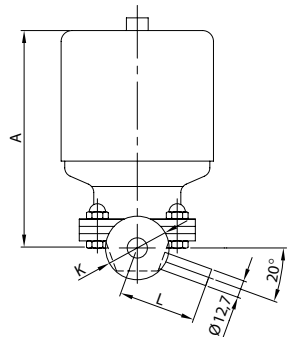

DN	A	K	L	gr
12	107,0	25,0	46,0	1.360
19	120,0	25,0	50,0	2.460
25	124,0	50,5	55,0	2.780
38	186,0	50,5	71,0	6.880
51	200,0	64,0	84,0	8.160



VALVOLE A MEMBRANA
DIAPHRAGM VALVES
VANNES À MEMBRANE
VÁLVULAS DE MEMBRANA

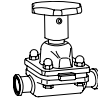

V. M. U. C. PREL. 20° EL.
20° SAMPL. D. V. C. UN. PE.
V. M. U. C. PR. ECH. 20° EL.
V. M. U. C. TOMAM. 20° EL.

D2L 60W

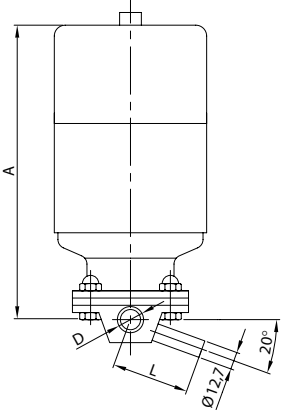

DN	A	D	L	gr
1/2 12	183,0	12,7	46,0	1.660
3/4 19	197,0	19,0	50,0	3.010
1 25	201,0	25,4	55,0	3.330
1 1/2 38	263,0	38,1	71,0	7.880
2 51	277,0	50,8	84,0	9.160

V. M. U. C. PREL. 20° E. SM.
20° SAMPL. D. V. C. UN. E. FR.
V. M. U. C. PR. ECH. 20° B. FR.
V. M. U. C. TOMAM. 20° E. SM.

D2L 60K

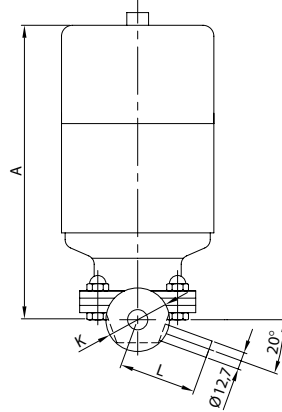

DN	A	K	L	gr
1/2 12	183,0	25,0	46,0	1.660
3/4 19	197,0	25,0	50,0	3.010
1 25	201,0	50,5	55,0	3.330
1 1/2 38	263,0	50,5	71,0	7.880
2 51	277,0	64,0	84,0	9.160

V. M. FONDO SERBATOIO EL.
TANK BOTTOM D. V. PE.
V. M. FOND CUVE BL.
V. M. FONDO TANQUE EL.

KTB 57W

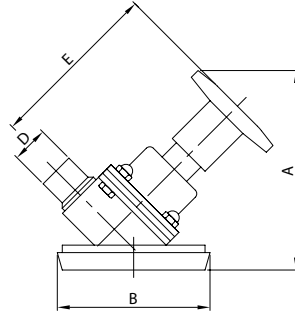

DN	A	B	D	E	gr
1/2 12	117,0	68,0	12,7	94,5	1.040
3/4 19	123,0	86,0	19,0	96,0	1.550
1 25	142,0	100,0	25,4	116,0	2.030
1 1/2 38	181,0	121,0	38,1	155,0	4.090
2 51	206,0	150,0	50,8	182,0	7.090

V. M. FONDO SERB. E. SM.
TANK BOTTOM D. V. E. FR.
V. M. FOND CUVE B. FR.
V. M. FONDO TANQUE E. SM.

KTB 57K

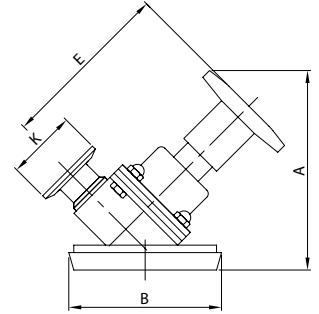

DN	A	B	E	K	gr
1/2 12	117,0	68,0	94,5	25,0	1.040
3/4 19	123,0	86,0	96,0	25,0	1.550
1 25	142,0	100,0	116,0	50,5	2.030
1 1/2 38	181,0	121,0	155,0	50,5	4.090
2 51	206,0	150,0	182,0	64,0	7.090

V. M. PNEUM. F. SERB. EL.
TANK B. PNEUM. D. V. PE.
V. M. PN. FOND CUVE BL.
V. M. NEUM. F. TANQUE EL.

KTB 58W

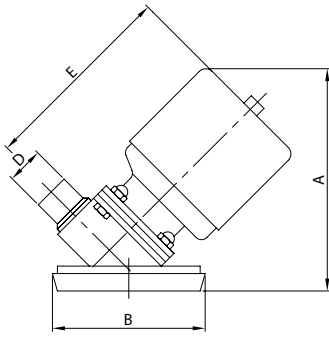

DN	A	B	D	E	gr
1/2 12	125,0	68,0	12,7	107,0	1.560
3/4 19	147,0	86,0	19,0	120,0	2.810
1 25	151,0	100,0	25,4	124,0	3.130
1 1/2 38	209,0	121,0	38,1	186,0	7.830
2 51	226,0	150,0	50,8	200,0	10.210

V. M. PN. F. SERB. E. SM.
TANK B. PNEUM. D. V. E. FR.
V. M. PN. FOND CUVE B. FR.
V. M. N. F. TANQUE E. SM.

KTB 58K

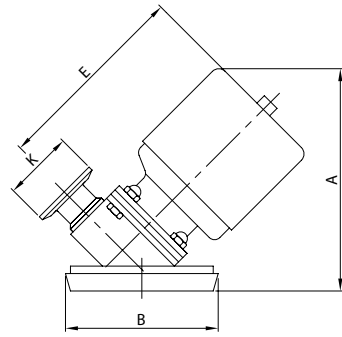

DN	A	B	E	K	gr
1/2 12	125,0	68,0	107,0	25,0	1.560
3/4 19	147,0	86,0	120,0	25,0	2.810
1 25	151,0	100,0	124,0	50,5	3.130
1 1/2 38	209,0	121,0	186,0	50,5	7.830
2 51	226,0	150,0	200,0	64,0	10.210

V. M. U. C. F. SERB. EL.
TANK B. D. V. C. UN. PE.
V. M. U. C. F. CUVE BL.
V. M. U. C. F. TANQUE EL.

KTB 60W

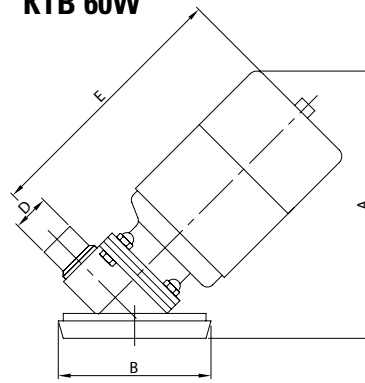

DN	A	B	D	E	gr
1/2 12	180,0	68,0	12,7	183,0	1.860
3/4 19	202,0	86,0	19,0	197,0	3.360
1 25	207,0	100,0	25,4	201,0	3.680
1 1/2 38	264,0	121,0	38,1	263,0	8.830
2 51	282,0	150,0	50,8	277,0	11.210

V. M. U. C. F. SERB. E. SM.
TANK B. D. V. C. UN. E. FR.
V. M. U. C. F. CUVE B. FR.
V. M. U. C. F. TANQUE E. SM.

KTB 60K

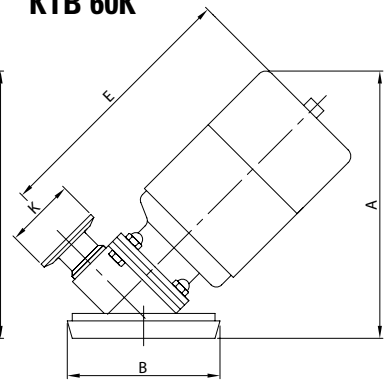

DN	A	B	E	K	gr
1/2 12	180,0	68,0	183,0	25,0	1.860
3/4 19	202,0	86,0	197,0	25,0	3.360
1 25	207,0	100,0	201,0	50,5	3.680
1 1/2 38	264,0	121,0	263,0	50,5	8.830
2 51	282,0	150,0	277,0	64,0	11.210



V. M. MODULANTE EL.
 MODULATING D. V. PE.
 V. M. MODULANTE BL.
 V. M. MODULANTE EL.

V. M. MODULANTE E. SM.
 MODULATING D. V. E. FR.
 V. M. MODULANTE B. FR.
 V. M. MODULANTE E. SM.

MEMBRANA EPDM
 EPDM DIAPHRAGM
 MEMBRANE EPDM
 MEMBRANA EPDM

MEMBRANA PTFE
 PTFE DIAPHRAGM
 MEMBRANE PTFE
 MEMBRANA PTFE

59W

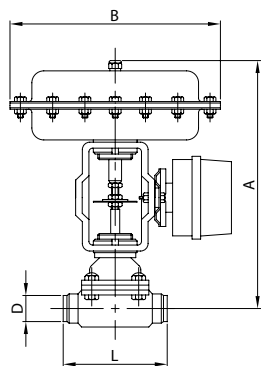

59K

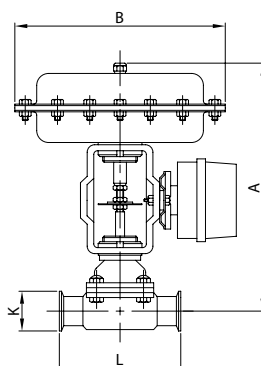

57 E 08

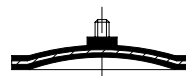

57 T 08

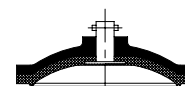

DN	A	B	D	L	gr
1/2 12	305,5	290,0	12,7	89,011.840	
3/4 19	307,0	290,0	19,0	102,012.200	
1 25	311,0	290,0	25,4	114,012.680	
1 1/2 38	330,5	290,0	38,1	140,014.140	
2 51	345,5	290,0	50,8	159,016.040	

DN	A	B	K	L	gr
1/2 12	305,5	290,0	25,0	89,011.840	
3/4 19	307,0	290,0	25,0	102,012.200	
1 25	311,0	290,0	50,5	114,012.680	
1 1/2 38	330,5	290,0	50,5	140,014.140	
2 51	345,5	290,0	64,0	159,016.040	

ELETTOVALVOLA NC.
 SOLENOID VALVE NC.
 ÉLECTROVANNE NF.
 ELECTROVÁLVULA NC.

CONNETTORE
 CONNECTOR
 CONNECTEUR
 CONECTOR

MICROINTERRUTTORE
 MICROSWITCH
 MINIRUPTEUR
 MICRORRUPTOR

CONTATTO DI PROSSIMITÀ
 PROXIMITY CONTACT
 CONTACT DE PROXIMITÉ
 MICROSENSOR

015 NC

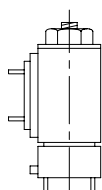

030 S

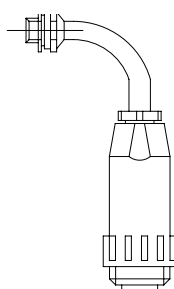

014 1

014 2

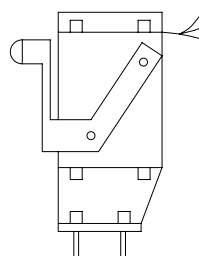

013 A
 013 A/N
 013 A/N/EX

